

# Nucleic Acid (Throughput-32) Automatic Extraction System



## Nucleic Acid Automatic Extraction System (Throughput-32)

**Product introduction:** With the latest isolation method of nucleic acid transferred by magnetic rods and preloaded magnetic beads-based extraction reagent, The YC701 Nucleic Acid Automatic Extraction System can process 1-12 samples and automatically isolate nucleic acids from various samples such as blood, cells, viruses, etc. The magnetic beads are adsorbed, transferred and released by the special magnetic rod, so as to realize the fully automated purification of nucleic acid.

### [Product Features]



#### Strong magnetic force:

high-performance magnetic rod ensure magnetic beads recovery rate  $\geq 98\%$ .



#### Avoid cross contamination:

intelligent cross contamination control system and UV sterilization module effectively reduce the cross contamination between wells.



#### Open system:

applicable to various magnetic beads-based extraction reagents.



#### Multiple modes:

pre-store multiple programs for different samples.



#### Precise temperature control:

automatic heating for lysis and elution, with fast heating speed and precise temperature control.



#### Easy operation:

7-inch touchable color screen to meet the needs of intelligent and convenient operation.



#### Short processing time:

up to 32 samples can be processed in 10-35min.

## Nucleic Acid Automatic Extraction System (Throughput-32)

### [Unique Magnetic Rod Movement]

The driving device is equipped with a high-performance stepping motor, with large magnetic rod vibration amplitude. The vibration amplitude can be set according to the volume of the solution to ensure good and even blending effect. The actuator is made of ball screw to ensure that the rod runs smoothly, has high precision and long service life. Each moving component is protected by the limit position protection mechanism to avoid instrument failure.

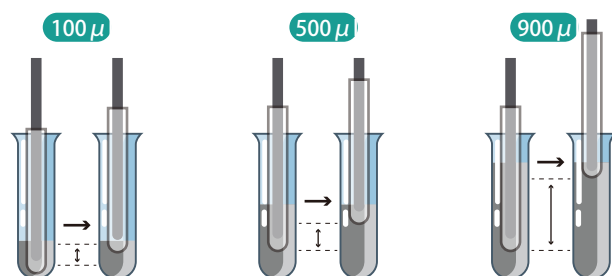

### [New Strong Magnetic rod]

With the newly designed strong magnetic rod, the magnetic beads are absorbed on the head of the magnetic rod, so as to ensure that the elution buffer can still cover all the magnetic beads even with a small elution volume. The high recovery of magnetic beads ensures high yield of nucleic acid.

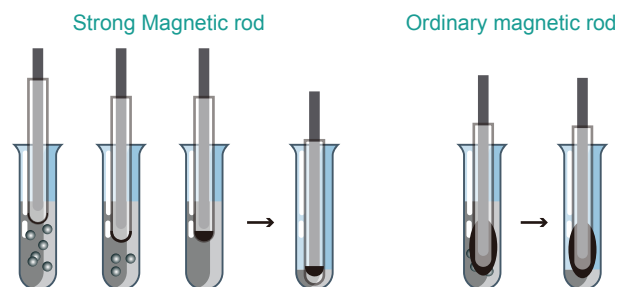

### [Working principle]

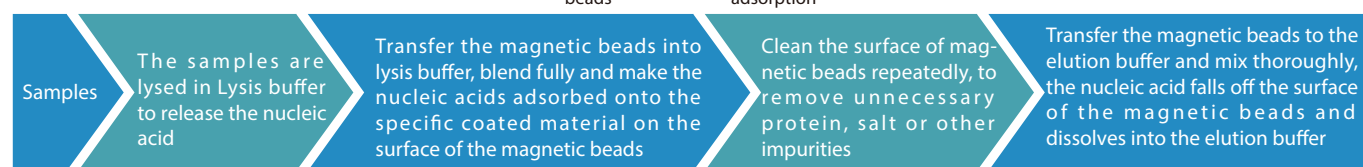
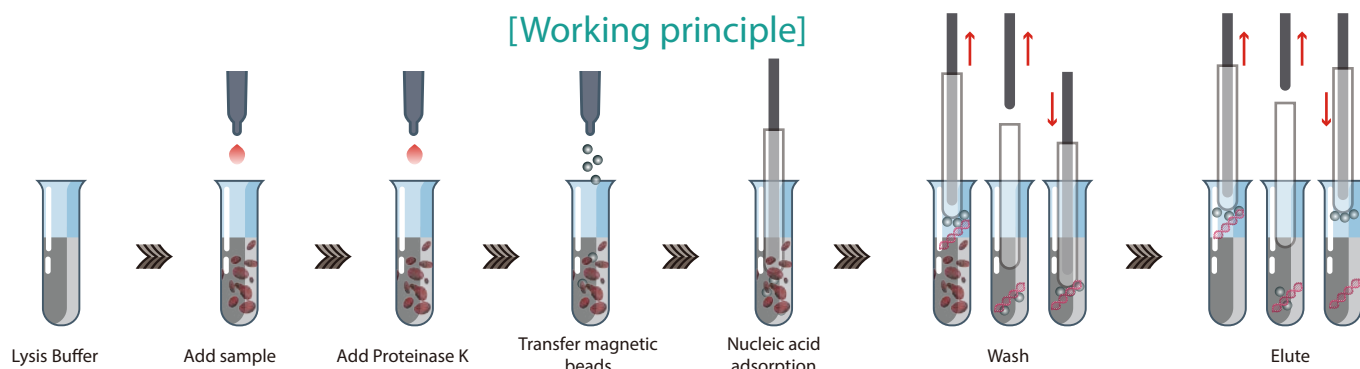

### [Instrument parameters]

Product name	Nucleic Acid Automatic Extraction System	Nucleic acid extraction purity	1.8≤OD260/OD280≤2.0
Model	YC702	Inter-well purification variation	CV<3%
Certification	CE/RoHS	Magnetic beads recovery	≥98%
Throughput	32 samples per run	Screen size	7-inch touchable color screen
Consumables	96 deep-well plate + magnetic rod sleeve	Disinfection/decontamination method	UV lamp
Nucleic acid extraction time	10-35 minutes	Input power	AC 100-240V ~ , 5.9-2.7A , 50/60Hz
Temperature control precision	0.5°C	Product weight	26.5±1kg
Temperature control accuracy	±1.5°C	Product size	550mm*450mm*550mm (L×W×H)
Heating range	Ambient temperature ~100°C		

Supporting reagent: (Preloaded Version for YC702)  
**Magnetic Bead-Based Nucleic Acid (DNA/RNA)  
Extraction Kit**

## [Product Introduction]

This kit is suitable for TECHSTAR YC701 Nucleic Acid Automatic Extraction System for extracting genomic DNA/RNA of pathogenic microorganisms from samples such as serum, plasma, cultured cells, saliva, alveolar lavage fluid, nasopharyngeal aspirates and swabs.

### [Product name]

Magnetic Bead-Based Nucleic Acid (DNA/RNA) Extraction Kit

### [Product No.]

SC906

### [Packing specification]

64 T/kit

### [Transportation condition]

Room temperature

### [Preservation condition]

Room temperature, or 2-8°C for long-term preservation

### [Period of validity]

12 months

### [Applicable instrument]

TECHSTAR YC702 Nucleic Acid Automatic Extraction System

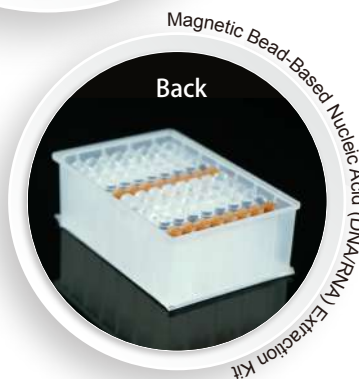
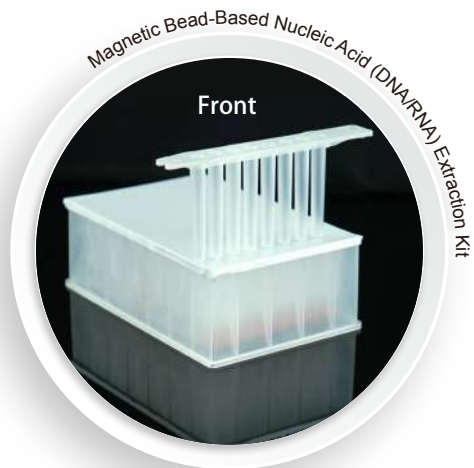

## [Features]

01

Unique room temperature stable proteinase K, all reagents in the kit do not need to be stored at low temperature.

02

The magnetic beads optimized for the genomic DNA/RNA of pathogenic microorganisms have excellent adsorption effect on small fragments of nucleic acids.

03

With high repeatability and yield, it is able to recover trace amount of pathogenic microorganism genomic DNA/RNA.

Supporting reagent: (Preloaded Version for YC702 )  
**Magnetic Bead-Based Nucleic Acid (DNA/RNA)  
 Extraction Kit**

## [Product components]

### [Product components]

Product name	Qty
Preloaded reagent plate	4 plates
Magnetic rod sleeve	8 strips
Proteinase K	1 tube

### [Preloaded location of reagent]

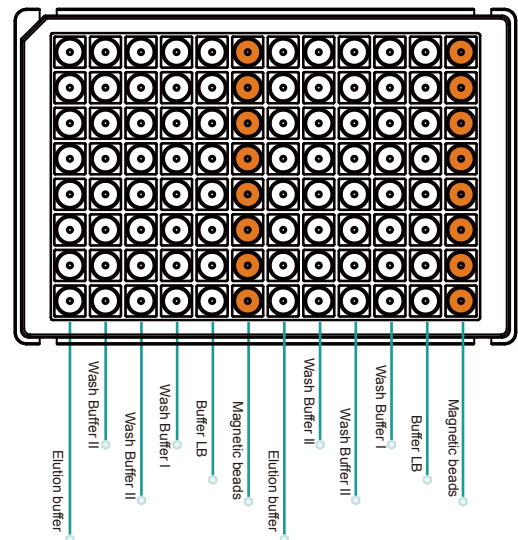

### [Product Dimensions]

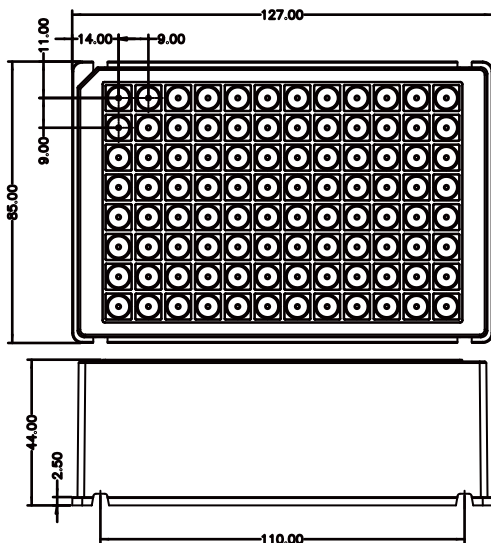

Preloaded reagent plate

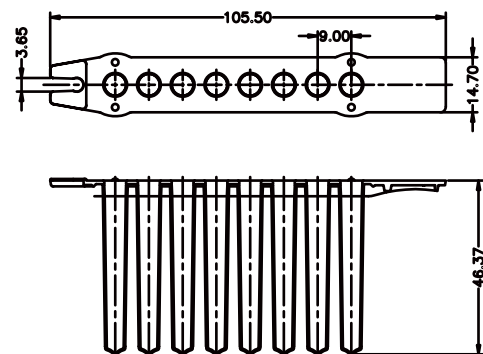

Magnetic rod sleeve

## [Operation procedures]



**JoJo Life Science UG** (haftungsbeschränkt)

**Biberstraße 32**

**89537 Giengen**

**Tel. 07322-9111329**

**Mail: [info@jojo-ls.de](mailto:info@jojo-ls.de)**

**Web: [www.jojo-ls.de](http://www.jojo-ls.de)**